

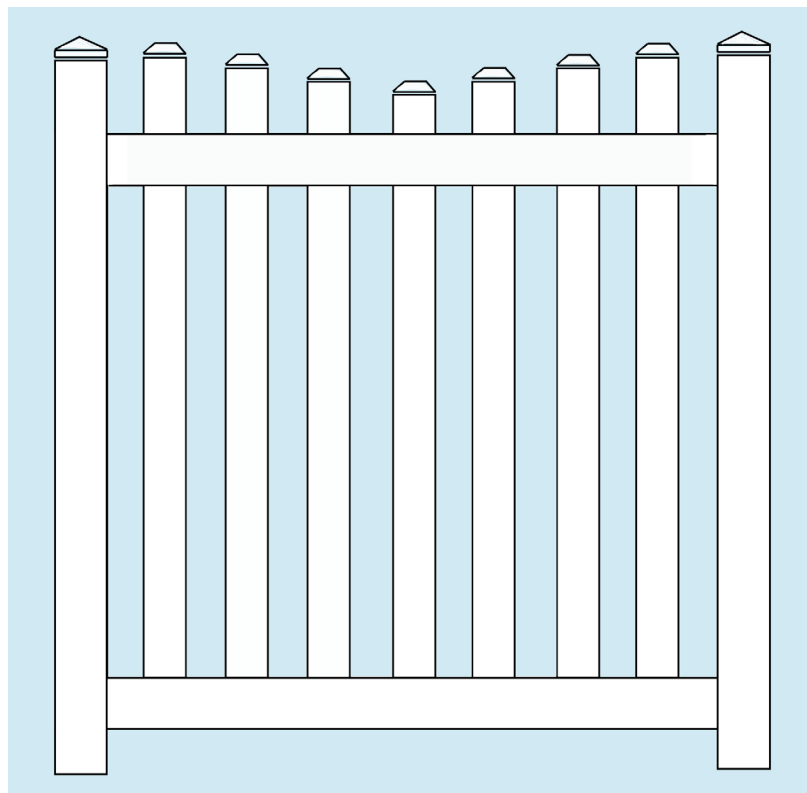

SHORELINE
VINYL SYSTEMS

Open Picket Panel and Gate Installation Instructions



Fence Layout

Step One

Locate property line and all underground wires and pipes. Check local codes to see if a fence permit is required.

Step Two

Using a string line and stakes, layout the desired fence application. If fence layout is on the property line, stay 4-6 inches in from the line to ensure concrete footings do not go over the property line.

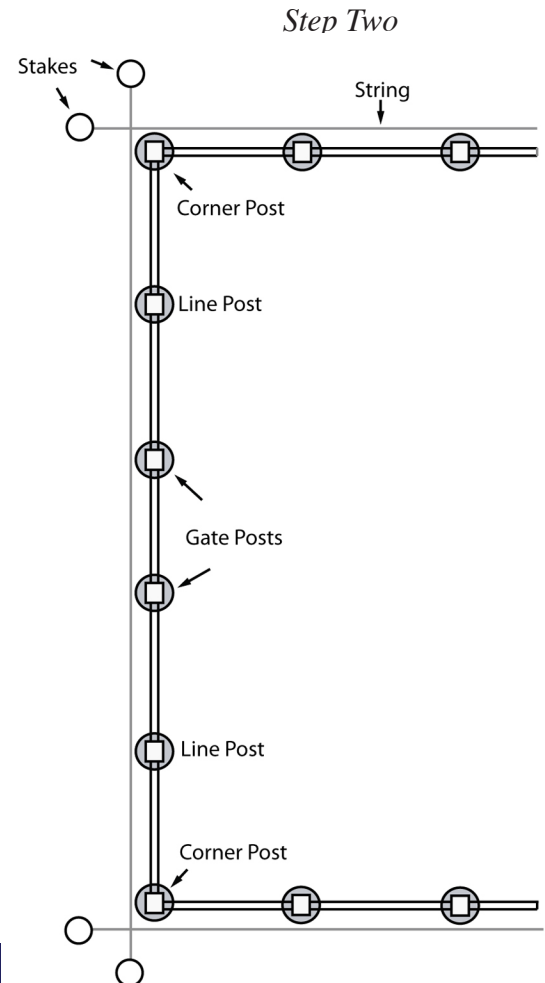

Step Three

Mark location of the gate posts with marking paint. The measurement in between posts will be the size of your gate.

For example: For a 4 ft. gate, set post 48 inches apart. The gate will be 1-1/2 inch smaller, to allow for hardware.

Step Three

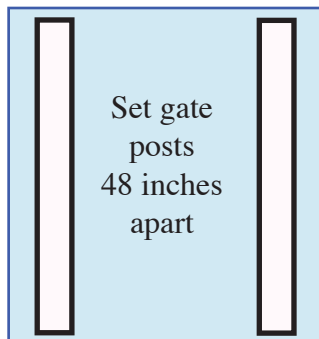

Step Four

With paint, layout remaining post holes to 8 ft. on center of post for 8 ft. section, or 6 ft. section on center for 6 ft. section.

Step Five

Begin to dig holes, approximately 7 inches to 8 inches in diameter and 36 inches deep. Make sure holes are 2 inches offset from string line.

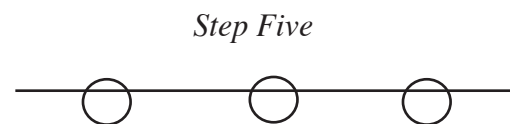

Setting the Posts

Step One

Position post in hole. Center the post, then square with the fence line, ensuring when the rails are placed they will be parallel to the string line. Check each post with a carpenter's level and adjust, if necessary, to ensure each is plumb. The fence height above grade must be determined at this time. Leave 2 inches from the bottom of the bottom rail to the ground.

Step Two

Pour concrete around posts up to ground level. Use either wet or dry concrete. When ready to set dry concrete, pour water around the posts, following concrete instructions. Concrete will set in approximately 24 hours. Repeat this step until all posts are set and you are ready to assemble panels and install gate, if you have one.

Step One & Two

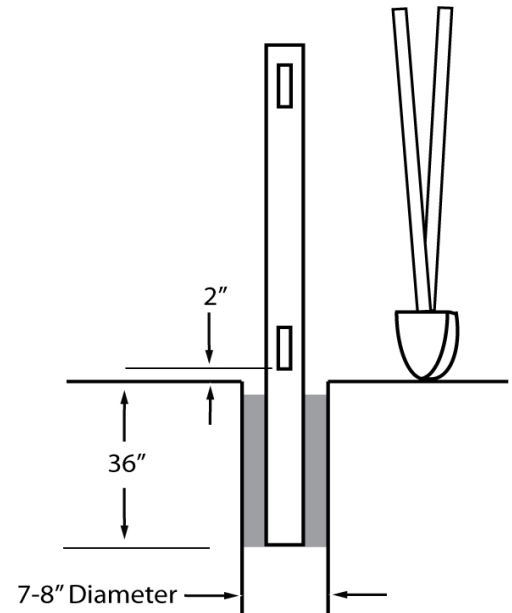

Panel Install

Step One

Note: Bottom rail may have aluminum, if ordered.

Slide the rails into the cutouts in the post. If the space between the posts is less than the panel size, cut the panel with any type of power saw. When cutting off a notch, place a screw in the side of the rail to act as a notch. to the desired length. Use any power saw to cut rails.

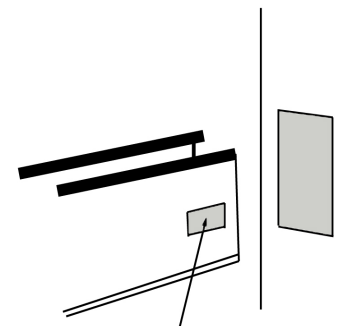

Locking Notch

Post Caps

Step One

Apply PVC glue inside the bottom perimeter of the cap and press securely onto the top of the post. Make sure the cap is on the post as far as it will go.

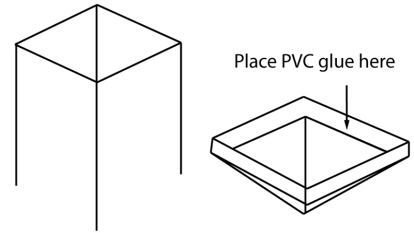

Hang Gates

Step One

Position the gate in the gate opening. Block up the gate, lining up the horizontal rails of the gate with the fence rails. For hinge placement, it is recommended that you place the top hinge 4 inches - 6 inches from the top of the gate frame and the bottom hinge 4 inches - 6 inches from the bottom of the bottom rail. For latch installation, follow the pre-packaged latch instructions, included with the latch.

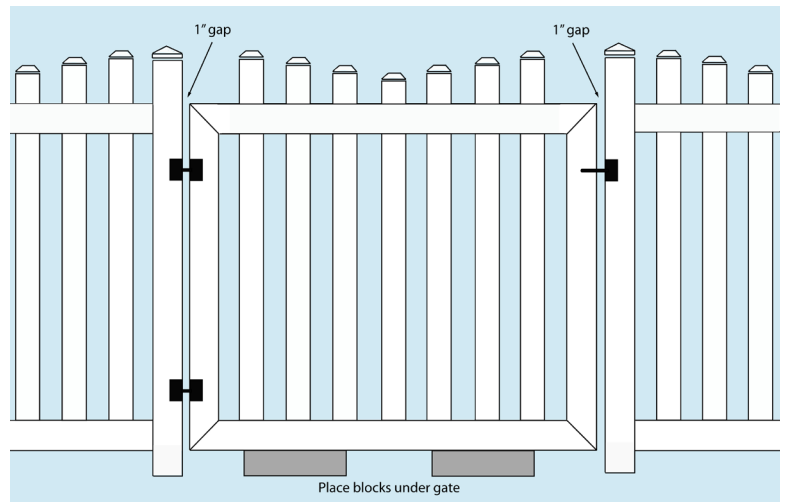

Cleanup

Your new fence may be dirty after installation. In most cases, simply hose any loose dirt off. For tougher stains, use soap and water or a non-abrasive cleaner applied with a rag.

